

Model Contribute to Overall Cost Reduction



For the most recent information on models that have been certified for safety standards, refer to your OMRON website.

E3JM Terminal Block Models

- Easy to wire and adjust.

Be sure to read *Safety Precautions* on page 7.

Ordering Information

Sensors (Refer to *Dimensions* on page 9.)

Sensing method	Appearance	Connection method	Sensing distance		Operation mode	Output configuration	Functions	Model
			Red light	Infrared light				
Through-beam (Emitter + Receiver) *		Terminal block	10 m		Light-ON Dark-ON (switch selectable)	Relay	---	E3JM-10M4-N Emitter: E3JM-10L-N Receiver: E3JM-10DM4-N
			Timer	E3JM-10M4T-N Emitter: E3JM-10L-N Receiver: E3JM-10DM4T-N				
			DC SSR	---		E3JM-10S4-N Emitter: E3JM-10L-N Receiver: E3JM-10DS4-N		
				Timer		E3JM-10S4T-N Emitter: E3JM-10L-N Receiver: E3JM-10DS4T-N		
Retro-reflective with MSR function	 E39-R1 (provided)	Terminal block	4 m		Light-ON Dark-ON (switch selectable)	Relay	---	E3JM-R4M4
			Timer	E3JM-R4M4T				
Diffuse-reflective		Terminal block	700 mm			DC SSR	---	E3JM-R4S4
			Timer	E3JM-R4S4T				
Diffuse-reflective		Terminal block	700 mm		Relay	---	E3JM-DS70M4	
			Timer	E3JM-DS70M4T				
Diffuse-reflective		Terminal block	700 mm		DC SSR	---	E3JM-DS70S4	
			Timer	E3JM-DS70S4T				

*Through-beam Sensors are sold in sets that include both the Emitter and Receiver.

Note: UL-listed models have the -US suffix. The model number for an E3JM Through-beam Sensor ends in "-US" (and not in "-N"). (Example: E3JM-10M4-US).

Tightening nuts, washers, and rubber bushings are not provided with these models.

Change: Shape of the E3JM conduit socket

Accessories (Order Separately)

Slit (A Slit is not provided with the Sensor for through-beam. Order a Slit separately if required.) (Refer to *Dimensions* on page 9.)

Slit width	Sensing distance	Minimum detectable object (reference value)	Model	Quantity	Remarks
1 mm × 20 mm	E3JM-10□4(T)-N	1.2 m	1-mm dia.	E39-S39	1 Slit each for the Emitter and Receiver (2 Slits total) (Seal-type long slit) Can be used with the E3JM-10□4(T)-N Models.

Reflectors (A Reflector is required for each Retro-reflective Sensor.)



The E39-R1 Reflector is provided with the Sensor. Order other Reflectors separately if required. (Refer to *Dimensions* on E39-L/E39-S/E39-R.)

Name	Sensing distance	Model	Quantity	Remarks
Reflectors	E3JM-R4□4(T)	4 m	E39-R1	1 Provided with the E3JM-R4□4(T)

Note: Refer to *Reflectors* on E39-L/E39-S/E39-R for details.

Mounting Bracket

Some Mounting Brackets are provided with the Sensor. Order other Mounting Brackets separately if required. (Refer to E39-L/E39-S/E39-R)

Appearance	Model	Quantity	Remarks
	E39-L53	1	Provided with the E3JM.
	E39-L51	1	Mounting Bracket designed for changing from the E3A-M, E3A2, E3A3, OA-5, or OA-5N to the E3JM.

Note: 1. When using a Through-beam Sensor, order one Connector for the Receiver and one for the Emitter.
2. Refer to *Mounting Brackets* on E39-L/E39-S/E39-R for details.

Ratings and Specifications

Sensing method		Through-beam model	Retro-reflective model (with MSR function)	Diffuse-reflective model
Item	Model	E3JM-10□4(T)-N	E3JM-R4□4(T)	E3JM-DS70□4(T)
Sensing distance		10 m	4 m (When using E39-R1)	White paper (200 × 200 mm): 700 mm
Standard sensing object		Opaque: 14.8-mm dia. min.	Opaque: 75-mm dia. min.	---
Differential travel		---		20% max. of sensing distance
Directional angle		Both Emitter and Receiver 3° to 20°	1° to 5°	---
Light source (wavelength)		Infrared LED (950 nm)	Red LED (660 nm)	Infrared LED (950 nm)
Power supply voltage		12 to 240 VDC±10%, ripple (p-p): 10% max. 24 to 240 VAC±10%, 50/60 Hz		
Power consumption	DC	3 W max. (Emitter 1 W max. Receiver 2 W max.)	2 W max.	
	AC	3 W max. (Emitter 1 W max. Receiver 2 W max.)	2 W max.	
Control output		Relay output (E3JM-□□M4 (T) model): SPDT, 250 VAC, 3A (cosφ=1) max., 5 VDC, 10 mA min. DC SSR output (E3JM-□□S4 (T) model): 48 VDC, 100 mA max. (residual voltage: 2 V max.) Light-ON/Dark-ON selectable		
Life expectancy (relay output)	Mechanical	50,000,000 times min. (switching frequency: 18,000 times/h)		
	Electrical	100,000 times min. (switching frequency: 1,800 times/h)		
Response time	Relay output	(E3JM-□□M4 (T) models) Operate or reset: 30 ms max.		
	DC SSR output	(E3JM-□□S4 (T) models) Operate or reset: 5 ms max.		
Sensitivity adjustment		---		One-turn adjuster
Timer function *		ON-delay/OFF-delay/One-shot delay switch selectable Delay time: 0.1 to 5 s (adjustable), only for E3JM-□□□4T		
Ambient illumination (Receiver side)		Incandescent lamp: 3,000 lx max.		
Ambient temperature range		Operating: -25°C to 55°C, Storage: -30°C to 70°C (with no icing or condensation)		
Ambient humidity range		Operating: 45% to 85% (with no condensation), Storage: 35% to 95% (with no condensation)		
Insulation resistance		20 MΩ min. at 500 VDC		
Dielectric strength		2,000 VAC, 50/60 Hz for 1 min.		
Vibration resistance	Destruction	10 to 55 Hz, 1.5-mm double amplitude for 2 hours each in X, Y, and Z directions		
	Malfunction	10 to 55 Hz, 1.5-mm double amplitude for 2 hours each in X, Y, and Z directions		
Shock resistance	Destruction	500 m/s ² 3 times each in X, Y, and Z directions		
	Malfunction	100 m/s ² 3 times each in X, Y, and Z directions		
Degree of protection		IEC 60529: IP66		
Connection method		Terminal block		
Weight (packed state)		Approx. 270 g	Approx. 160 g	
Material	Case	ABS (Acrylonitril Butadiene Styrene)		
	Lens	Methacrylic resin		
	Cover	Polycarbonate		
	Mounting Bracket	Iron		
Accessories		Mounting Bracket (with screw), Nuts, Terminal Protection Cover, One set of cable connection nuts (excluding -US Models), Instruction manual, Reflector (E39-R1: only for Retro-reflective Sensors)		

*The timer cannot be disabled for models with timer functions (E3JM-□□□4T).

Engineering Data (Reference Value)

Parallel Operating Range

Through-beam

E3JM-10□4(T)-N

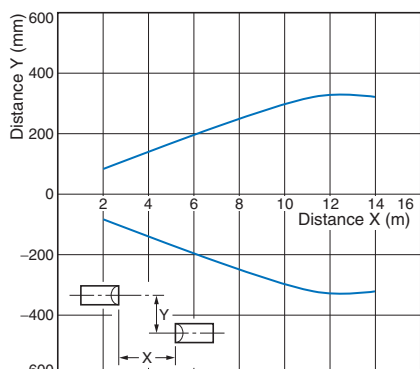

Through-beam

E3JM-10□4(T)-N + E39-S39 (Optional Slit)
(A Slit is mounted to the Emitter and Receiver.)

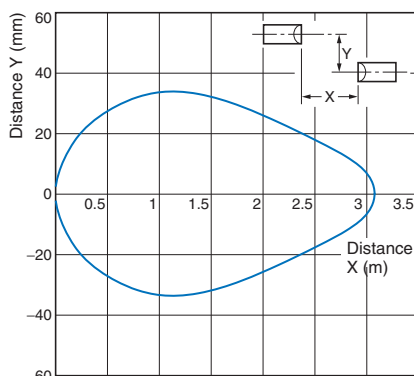

Retro-reflective

E3JM-R4□4(T) + E39-R1
(Supplied Reflector)

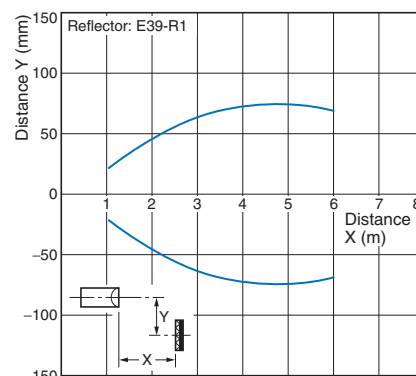

Operating Range

Diffuse-reflective

E3JM-DS70□4(T)

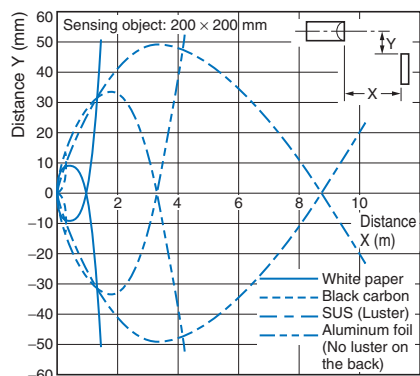

Excess Gain Ratio vs. Set Distance

Through-beam

E3JM-10□4(T)-N

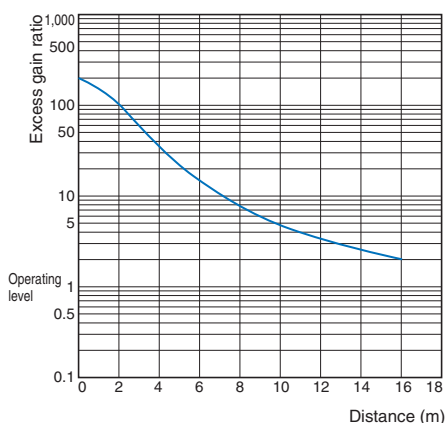

Retro-reflective

E3JM-R4□4(T) + E39-R1
(Supplied Reflector)

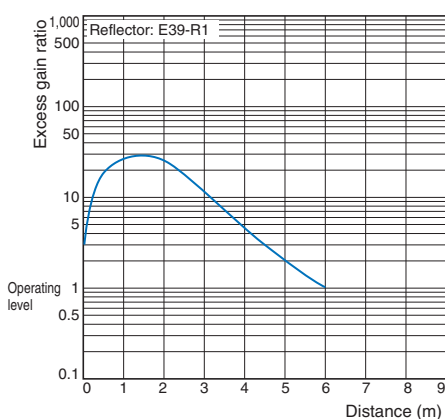

E3JM-R4□4(T) + E39-R3
(Optional Reflector)

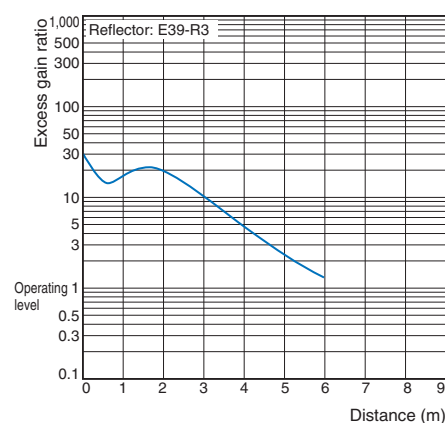

Diffuse-reflective

E3JM-DS70□4(T)

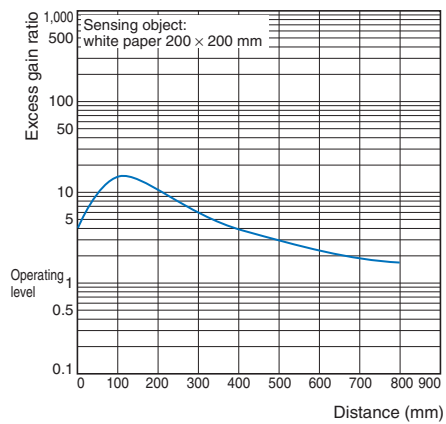

Sensing Object Size vs. Sensing Distance

E3JM-DS70□4(T)

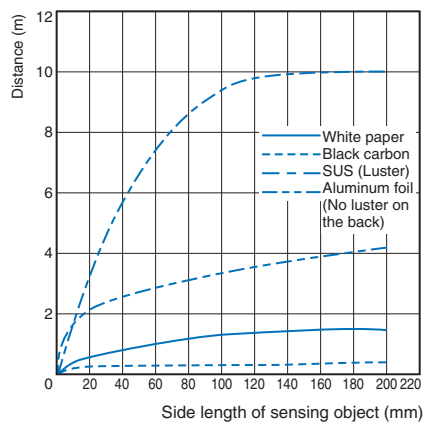

I/O Circuit Diagrams

Relay Output Models

Model	Timing chart	Output circuit
E3JM-10M4(T)-N *1 E3JM-R4M4(T) E3JM-DS70M4(T)	<p>Incident light: ON (green bar), No incident light: OFF (white bar)</p> <p>Indicator (red) *2: ON (green bar), OFF (white bar)</p> <p>L-ON (Ta): ON (green bar), OFF (white bar)</p> <p>D-ON (Ta): ON (green bar), OFF (white bar)</p> <p>Refer to page 7 for information on Sensors with timers (T).</p>	<p>24 to 240 VAC 12 to 240 VDC</p> <p>Power Source No polarity</p> <p>Photoelectric Sensor main circuit</p> <p>1, 2, 3, 4, 5</p> <p>Tb, Tc, Ta</p> <p>Contact output</p> <p>(Built-in Relay: G6C)</p>

DC SSR Output Models

Model	Timing chart	Output circuit
E3JM-10S4(T)-N *1 E3JM-R4S4(T) E3JM-DS70S4(T)	<p>Incident light: ON (green bar), No incident light: OFF (white bar)</p> <p>Indicator (red) *2: ON (green bar), OFF (white bar)</p> <p>L-ON (Ta): ON (green bar), OFF (white bar)</p> <p>D-ON (Ta): ON (green bar), OFF (white bar)</p> <p>Refer to page 7 for information on Sensors with timers (T).</p>	<p>24 to 240 VAC 12 to 240 VDC</p> <p>Power Source No polarity</p> <p>Photoelectric Sensor main circuit</p> <p>1, 2, 3, 4, 5</p> <p>L/ON, D/ON, COM</p> <p>Load, Load</p> <p>I1, I2</p> <p>48 VDC max.</p> <p>$I_1 + I_2 < 100 \text{ mA}$</p>

Note: Connect terminal 1 to any polarity and terminal 2 to the power supply because there is no polarity on the Emitter side.

*1. Models numbers for Through-beam Sensors (E3JM-10□4(T)-N) are for sets that include both the Emitter and Receiver.

The model number of the Emitter is always E3JM-10L-N. Add a "D" to get the model number of the Receiver (example: E3JM-10DM4-N). Confirm the model numbers of the Emitter and Receiver in *Ordering Information*.

*2. This is the light indicator on Sensors without a timer and the operation indicator on Sensors with a timer.

Safety Precautions

Refer to *Warranty and Limitations of Liability*.

⚠ WARNING

This product is not designed or rated for ensuring safety of persons either directly or indirectly. Do not use it for such purposes.



Precautions for Correct Use

Do not use the product in atmospheres or environments that exceed product ratings.

● **Designing**

Operation

Note: The white part of the DIP switch indicates which setting is selected.

	Switch configuration	Switch selection	Timing charts												
Models without timer	<p>MODE 0 ↔ 1</p> <p>D-ON <input type="checkbox"/> L-ON <input checked="" type="checkbox"/></p> <p>Operation selector</p>	<p>MODE 0 ↔ 1</p> <p>D-ON <input checked="" type="checkbox"/> L-ON <input type="checkbox"/> ← Light-ON, Relay ON, DC output switching element ON</p> <p>MODE 0 ↔ 1</p> <p>D-ON <input type="checkbox"/> L-ON <input checked="" type="checkbox"/> ← Dark-ON, Relay ON, DC output switching element ON</p>													
Models with timer	<p>MODE 0 ↔ 1</p> <p>D-ON <input type="checkbox"/> L-ON <input checked="" type="checkbox"/></p> <p>TIMER <input type="checkbox"/> SW1 <input checked="" type="checkbox"/> SW2 <input type="checkbox"/></p> <p>Operation Selector</p> <p>Selector switch for timer mode</p>	<table border="1"> <thead> <tr> <th>ON-delay</th> <th>OFF-delay</th> <th>One-shot delay</th> </tr> </thead> <tbody> <tr> <td> <p>MODE 0 ↔ 1</p> <p>D-ON <input type="checkbox"/> L-ON <input checked="" type="checkbox"/></p> <p>TIMER <input type="checkbox"/> SW1 <input checked="" type="checkbox"/> SW2 <input type="checkbox"/></p> <p>Both SW1 and SW2 at "0."</p> </td> <td> <p>MODE 0 ↔ 1</p> <p>D-ON <input type="checkbox"/> L-ON <input checked="" type="checkbox"/></p> <p>TIMER <input type="checkbox"/> SW1 <input type="checkbox"/> SW2 <input checked="" type="checkbox"/></p> <p>Only SW2 at "1."</p> </td> <td> <p>MODE 0 ↔ 1</p> <p>D-ON <input type="checkbox"/> L-ON <input checked="" type="checkbox"/></p> <p>TIMER <input type="checkbox"/> SW1 <input checked="" type="checkbox"/> SW2 <input type="checkbox"/></p> <p>Only SW1 at "1," which overrides either setting of SW2.</p> </td> </tr> </tbody> </table> <p>Note: The operation selector is the same as that for models without a timer.</p>	ON-delay	OFF-delay	One-shot delay	<p>MODE 0 ↔ 1</p> <p>D-ON <input type="checkbox"/> L-ON <input checked="" type="checkbox"/></p> <p>TIMER <input type="checkbox"/> SW1 <input checked="" type="checkbox"/> SW2 <input type="checkbox"/></p> <p>Both SW1 and SW2 at "0."</p>	<p>MODE 0 ↔ 1</p> <p>D-ON <input type="checkbox"/> L-ON <input checked="" type="checkbox"/></p> <p>TIMER <input type="checkbox"/> SW1 <input type="checkbox"/> SW2 <input checked="" type="checkbox"/></p> <p>Only SW2 at "1."</p>	<p>MODE 0 ↔ 1</p> <p>D-ON <input type="checkbox"/> L-ON <input checked="" type="checkbox"/></p> <p>TIMER <input type="checkbox"/> SW1 <input checked="" type="checkbox"/> SW2 <input type="checkbox"/></p> <p>Only SW1 at "1," which overrides either setting of SW2.</p>	<table border="1"> <thead> <tr> <th>ON-delay</th> <th>OFF-delay</th> <th>One-shot delay</th> </tr> </thead> <tbody> <tr> <td> </td> <td> </td> <td> </td> </tr> </tbody> </table>	ON-delay	OFF-delay	One-shot delay			
ON-delay	OFF-delay	One-shot delay													
<p>MODE 0 ↔ 1</p> <p>D-ON <input type="checkbox"/> L-ON <input checked="" type="checkbox"/></p> <p>TIMER <input type="checkbox"/> SW1 <input checked="" type="checkbox"/> SW2 <input type="checkbox"/></p> <p>Both SW1 and SW2 at "0."</p>	<p>MODE 0 ↔ 1</p> <p>D-ON <input type="checkbox"/> L-ON <input checked="" type="checkbox"/></p> <p>TIMER <input type="checkbox"/> SW1 <input type="checkbox"/> SW2 <input checked="" type="checkbox"/></p> <p>Only SW2 at "1."</p>	<p>MODE 0 ↔ 1</p> <p>D-ON <input type="checkbox"/> L-ON <input checked="" type="checkbox"/></p> <p>TIMER <input type="checkbox"/> SW1 <input checked="" type="checkbox"/> SW2 <input type="checkbox"/></p> <p>Only SW1 at "1," which overrides either setting of SW2.</p>													
ON-delay	OFF-delay	One-shot delay													

Output Relay Contact

If E3JM is connected to a load with contacts that spark when the load is turned OFF (e.g., a contactor or valve), the normally-closed side may be turned ON before the normally-open side is turned OFF or vice-versa. If both normally-open output and normally-closed output are used simultaneously, apply a surge suppressor to the load.

Refer to *OMRON's PCB Relays Catalog (X33)* for typical examples of surge suppressors.

● **Wiring**

Connecting and Wiring

- We recommend connecting a cable with a conductor cross-section of 0.3 mm² and an outer diameter of 6 to 8 mm.
- Be sure to firmly tighten the cover in order to maintain waterproof and dustproof properties. The screw size of the conduit sockets is shown in the following table.

Model	Conduit socket thread size
E3JM-□	PF1/2

- When using the DC SSR output model, the total of the load current for the Light-ON output (NO) and that for the Dark-ON (NC) should be 100 mA max. If the total exceeds 100 mA, the load short-circuit protection function will be activated (this function will be reset when the power of the Photoelectric Sensor is turned OFF).

Cable End Treatment

Adjust the four wires to the same length when the Ta output is to be used only. If both the Ta and Tb outputs are to be used, treat them as shown in the following diagram.

Recommended example

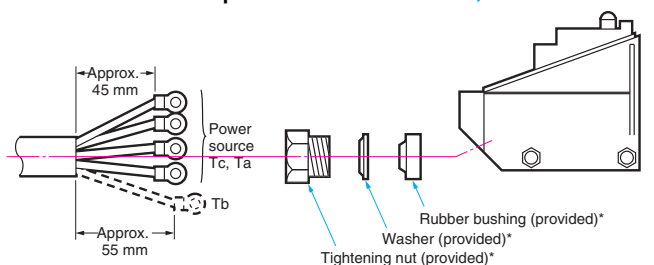

* These parts are not provided with models with a -US suffix.

Recommended Crimp Terminal Dimensions (Unit: mm)

Round type	Fork type
<p>(After crimping)</p>	<p>(After crimping)</p>

Note: Use terminals with insulation tube (recommended crimp terminal: 1.25 to 3.5).

● **Others**

Terminal Protection Cover (Provided)

The terminal protection cover is designed to improve safety by maintaining the sensitivity properties of the product and by preventing any contact with charged sections while it is being operated with the mode set to the timer mode. Mount the product as shown in the following diagram (mount the Through-beam Model on the Receiver side).

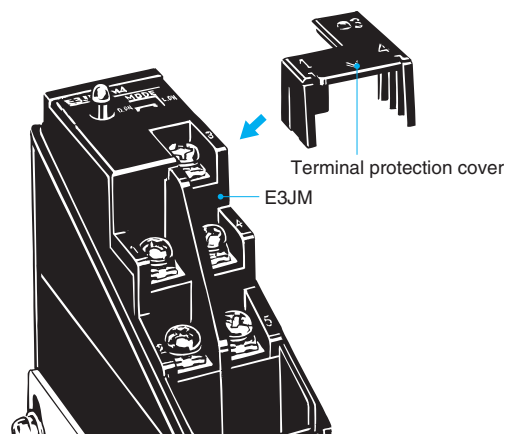

Ambient Conditions (Installation Area)

- The E3JM will malfunction if installed in the following places.
- Places where the E3JM is exposed to a dusty environment.
 - Places where corrosive gases are produced.

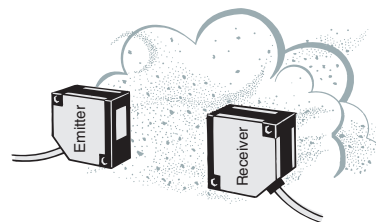

- Places where the E3JM is directly exposed to water, oil, or chemicals.

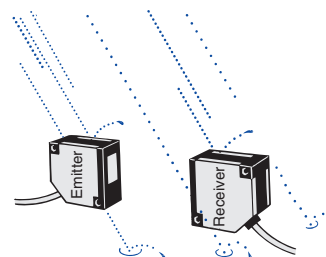

Dimensions

Sensors

E3JM-10□4(T)-N *

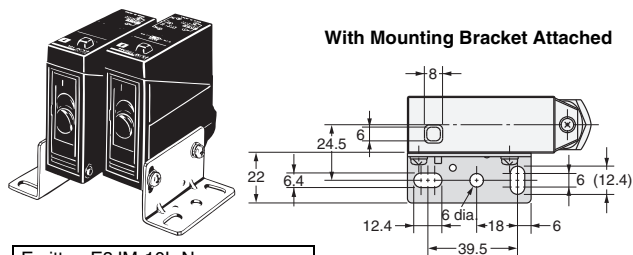

Emitter: E3JM-10L-N
Receiver: E3JM-10D□4 (T) -N

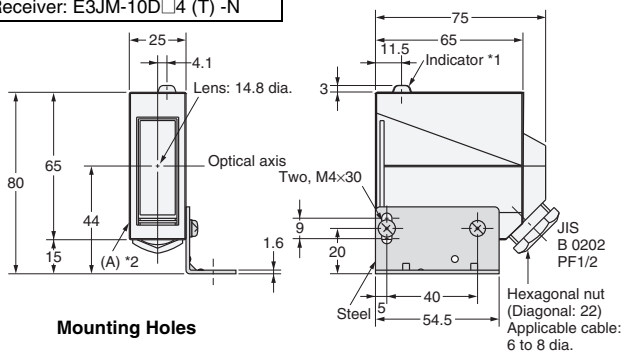

Mounting Holes

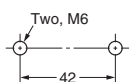

*1. Emitter: Power indicator
Receiver: Light indicator (without timer function)
Operation indicator (with timer function)
*2. Mounting Brackets can be used on the A side.

Note: The operating mode switch and timer mode switch are located inside the cover.

E3JM-R4□4(T) E3JM-DS70□4(T)

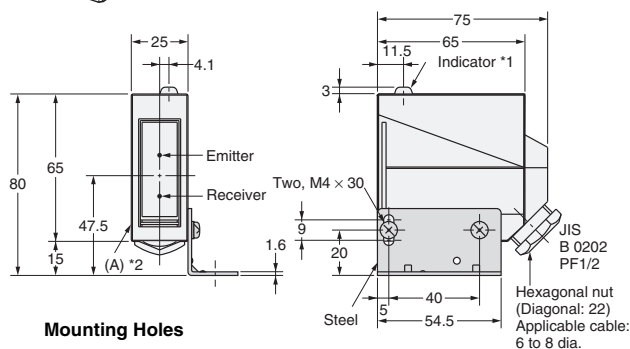
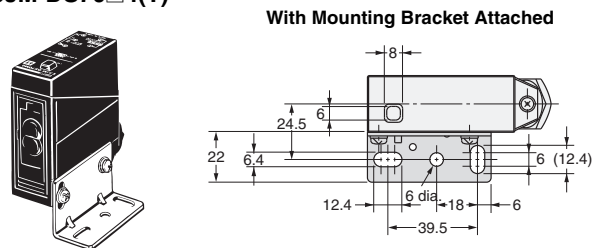

Mounting Holes

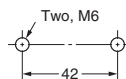

*1. Light indicator (without timer function)
Operation indicator (with timer function)
*2. Mounting Brackets can be used on the A side.

Note: The operating mode switch, timer mode switch, and sensitivity adjuster (sensitivity adjuster: E3JM-DS70□4(T) only) are located inside the cover.

* Models numbers for Through-beam Sensors (E3JM-10□4(T)-N) are for sets that include both the Emitter and Receiver.
The model number of the Emitter is always E3JM-10L-N. Add a "D" to get the model number of the Receiver (example: EE3JM-10DM4-N). Confirm the model numbers of the Emitter and Receiver in *Ordering Information*.

Accessories (Order separately)

Seal-type Long Slit

E39-S39



Materials: Polyester
0.1-mm thick

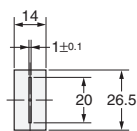

Mounting Brackets

Refer to E39-L/E39-S/E39-R for details.

Terms and Conditions Agreement

Read and understand this catalog.

Please read and understand this catalog before purchasing the products. Please consult your OMRON representative if you have any questions or comments.

Warranties.

(a) Exclusive Warranty. Omron's exclusive warranty is that the Products will be free from defects in materials and workmanship for a period of twelve months from the date of sale by Omron (or such other period expressed in writing by Omron). Omron disclaims all other warranties, express or implied.

(b) Limitations. OMRON MAKES NO WARRANTY OR REPRESENTATION, EXPRESS OR IMPLIED, ABOUT NON-INFRINGEMENT, MERCHANTABILITY OR FITNESS FOR A PARTICULAR PURPOSE OF THE PRODUCTS. BUYER ACKNOWLEDGES THAT IT ALONE HAS DETERMINED THAT THE PRODUCTS WILL SUITABLY MEET THE REQUIREMENTS OF THEIR INTENDED USE.

Omron further disclaims all warranties and responsibility of any type for claims or expenses based on infringement by the Products or otherwise of any intellectual property right. (c) Buyer Remedy. Omron's sole obligation hereunder shall be, at Omron's election, to (i) replace (in the form originally shipped with Buyer responsible for labor charges for removal or replacement thereof) the non-complying Product, (ii) repair the non-complying Product, or (iii) repay or credit Buyer an amount equal to the purchase price of the non-complying Product; provided that in no event shall Omron be responsible for warranty, repair, indemnity or any other claims or expenses regarding the Products unless Omron's analysis confirms that the Products were properly handled, stored, installed and maintained and not subject to contamination, abuse, misuse or inappropriate modification. Return of any Products by Buyer must be approved in writing by Omron before shipment. Omron Companies shall not be liable for the suitability or unsuitability or the results from the use of Products in combination with any electrical or electronic components, circuits, system assemblies or any other materials or substances or environments. Any advice, recommendations or information given orally or in writing, are not to be construed as an amendment or addition to the above warranty.

See <http://www.omron.com/global/> or contact your Omron representative for published information.

Limitation on Liability; Etc.

OMRON COMPANIES SHALL NOT BE LIABLE FOR SPECIAL, INDIRECT, INCIDENTAL, OR CONSEQUENTIAL DAMAGES, LOSS OF PROFITS OR PRODUCTION OR COMMERCIAL LOSS IN ANY WAY CONNECTED WITH THE PRODUCTS, WHETHER SUCH CLAIM IS BASED IN CONTRACT, WARRANTY, NEGLIGENCE OR STRICT LIABILITY.

Further, in no event shall liability of Omron Companies exceed the individual price of the Product on which liability is asserted.

Suitability of Use.

Omron Companies shall not be responsible for conformity with any standards, codes or regulations which apply to the combination of the Product in the Buyer's application or use of the Product. At Buyer's request, Omron will provide applicable third party certification documents identifying ratings and limitations of use which apply to the Product. This information by itself is not sufficient for a complete determination of the suitability of the Product in combination with the end product, machine, system, or other application or use. Buyer shall be solely responsible for determining appropriateness of the particular Product with respect to Buyer's application, product or system. Buyer shall take application responsibility in all cases.

NEVER USE THE PRODUCT FOR AN APPLICATION INVOLVING SERIOUS RISK TO LIFE OR PROPERTY OR IN LARGE QUANTITIES WITHOUT ENSURING THAT THE SYSTEM AS A WHOLE HAS BEEN DESIGNED TO ADDRESS THE RISKS, AND THAT THE OMRON PRODUCT(S) IS PROPERLY RATED AND INSTALLED FOR THE INTENDED USE WITHIN THE OVERALL EQUIPMENT OR SYSTEM.

Programmable Products.

Omron Companies shall not be responsible for the user's programming of a programmable Product, or any consequence thereof.

Performance Data.

Data presented in Omron Company websites, catalogs and other materials is provided as a guide for the user in determining suitability and does not constitute a warranty. It may represent the result of Omron's test conditions, and the user must correlate it to actual application requirements. Actual performance is subject to the Omron's Warranty and Limitations of Liability.

Change in Specifications.

Product specifications and accessories may be changed at any time based on improvements and other reasons. It is our practice to change part numbers when published ratings or features are changed, or when significant construction changes are made. However, some specifications of the Product may be changed without any notice. When in doubt, special part numbers may be assigned to fix or establish key specifications for your application. Please consult with your Omron's representative at any time to confirm actual specifications of purchased Product.

Errors and Omissions.

Information presented by Omron Companies has been checked and is believed to be accurate; however, no responsibility is assumed for clerical, typographical or proofreading errors or omissions.